

4 - 8 YEARS



First Aid  
Reference  
Centre

# PREVENTION OF

# DOMESTIC ACCIDENTS

Color the **dangerous elements** in each scene.

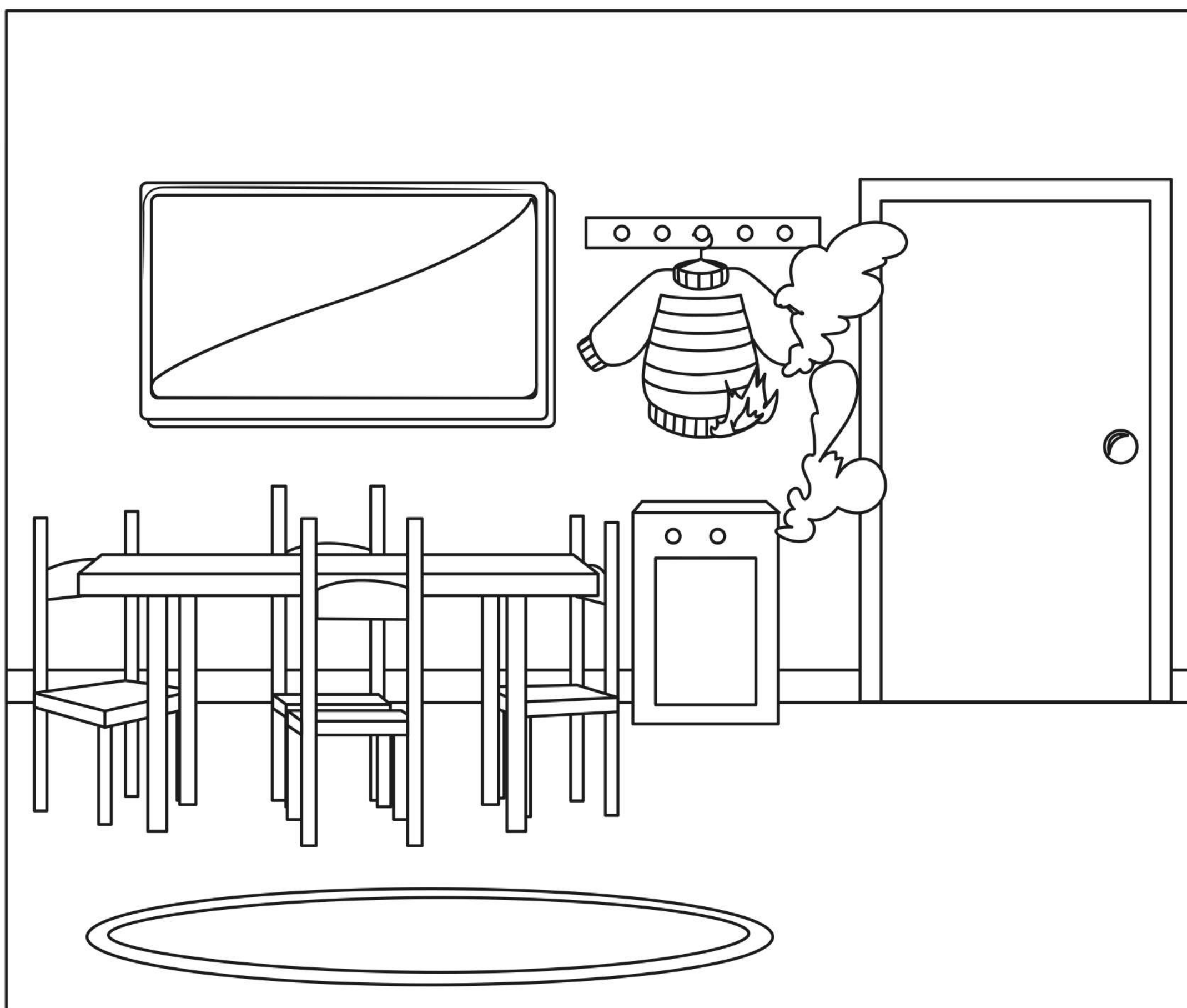
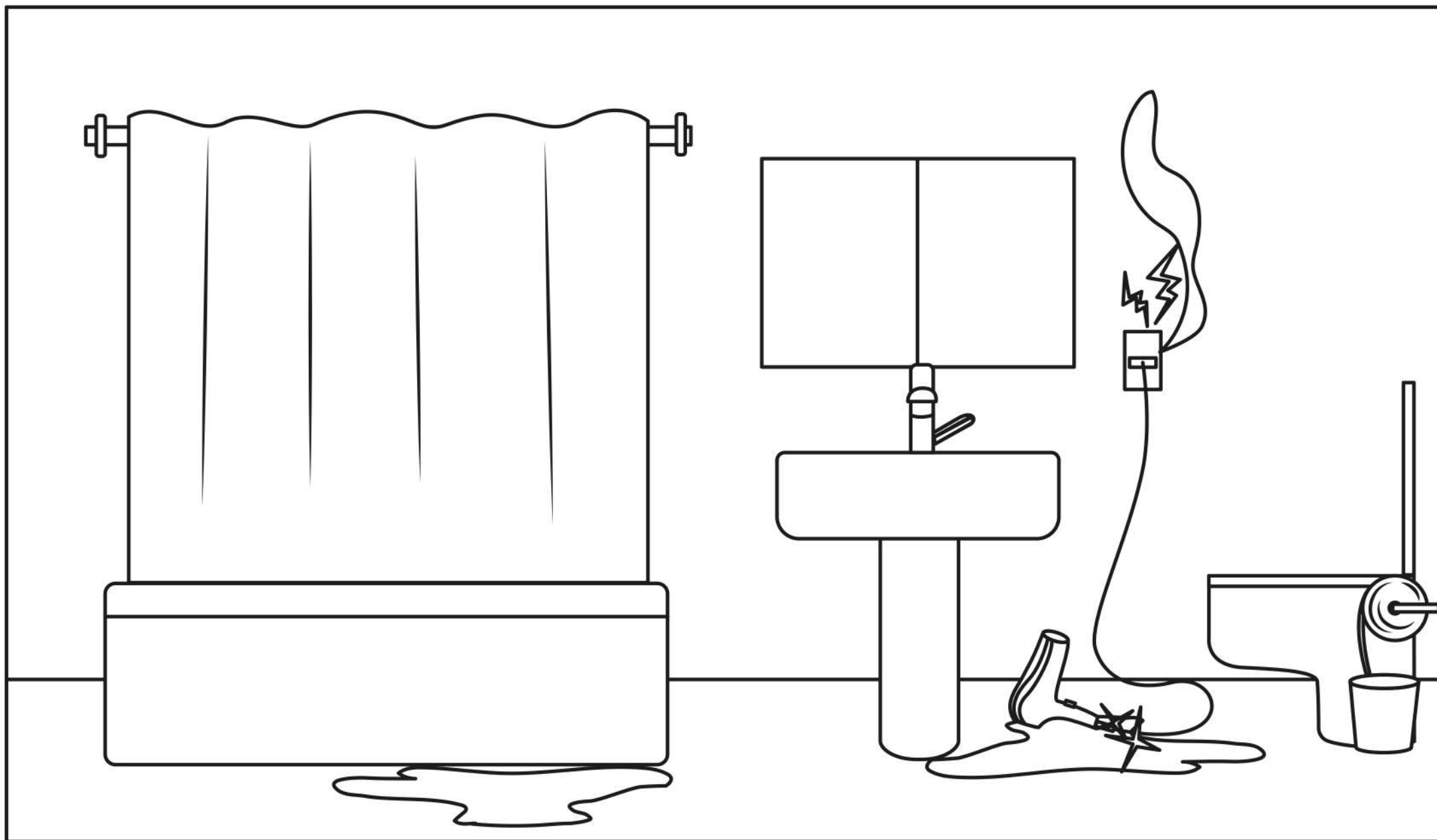

4-8 YEARS



First Aid  
Reference  
Centre

# PREVENTION OF

# DOMESTIC ACCIDENTS

Color the **dangerous elements** in each scene.

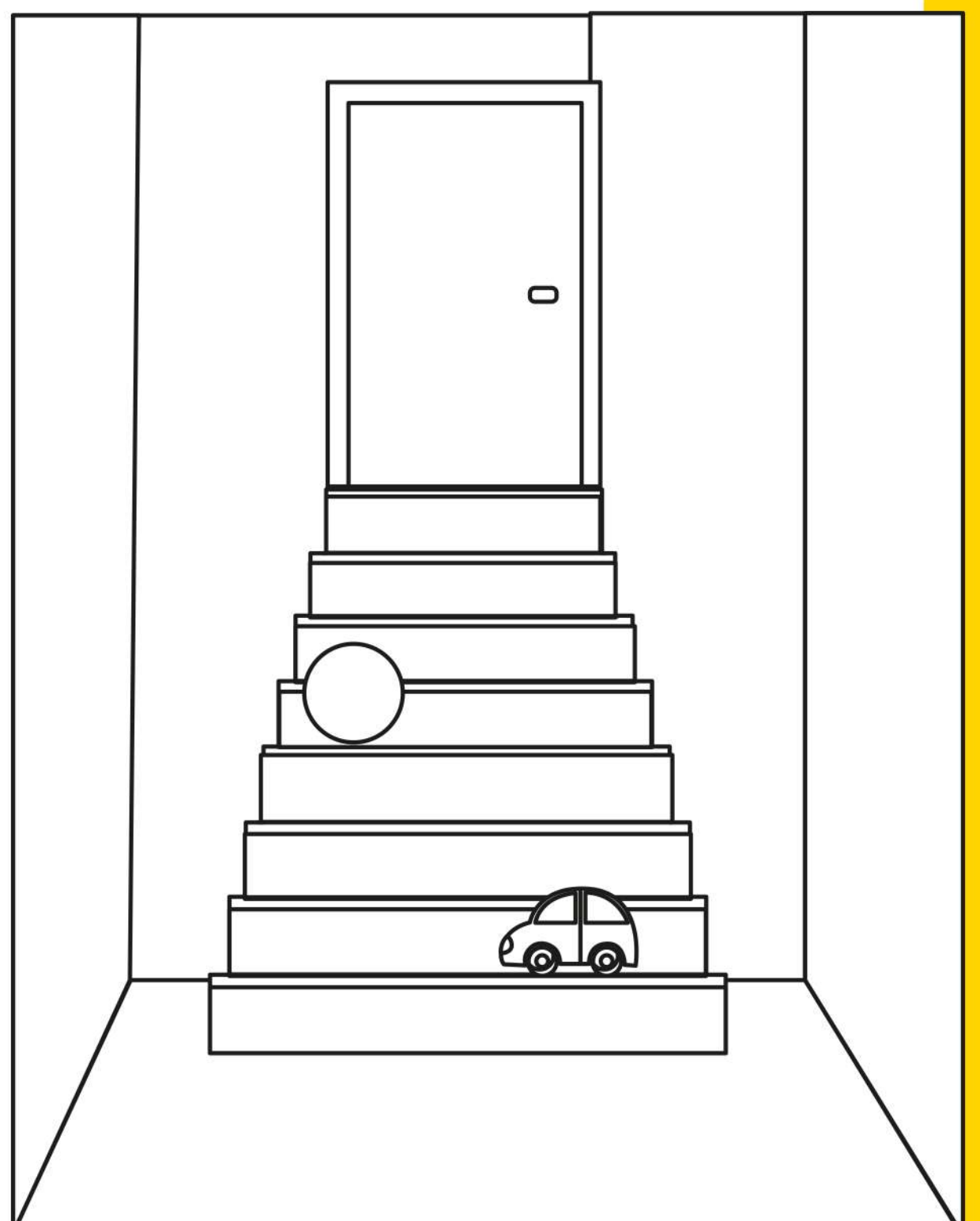
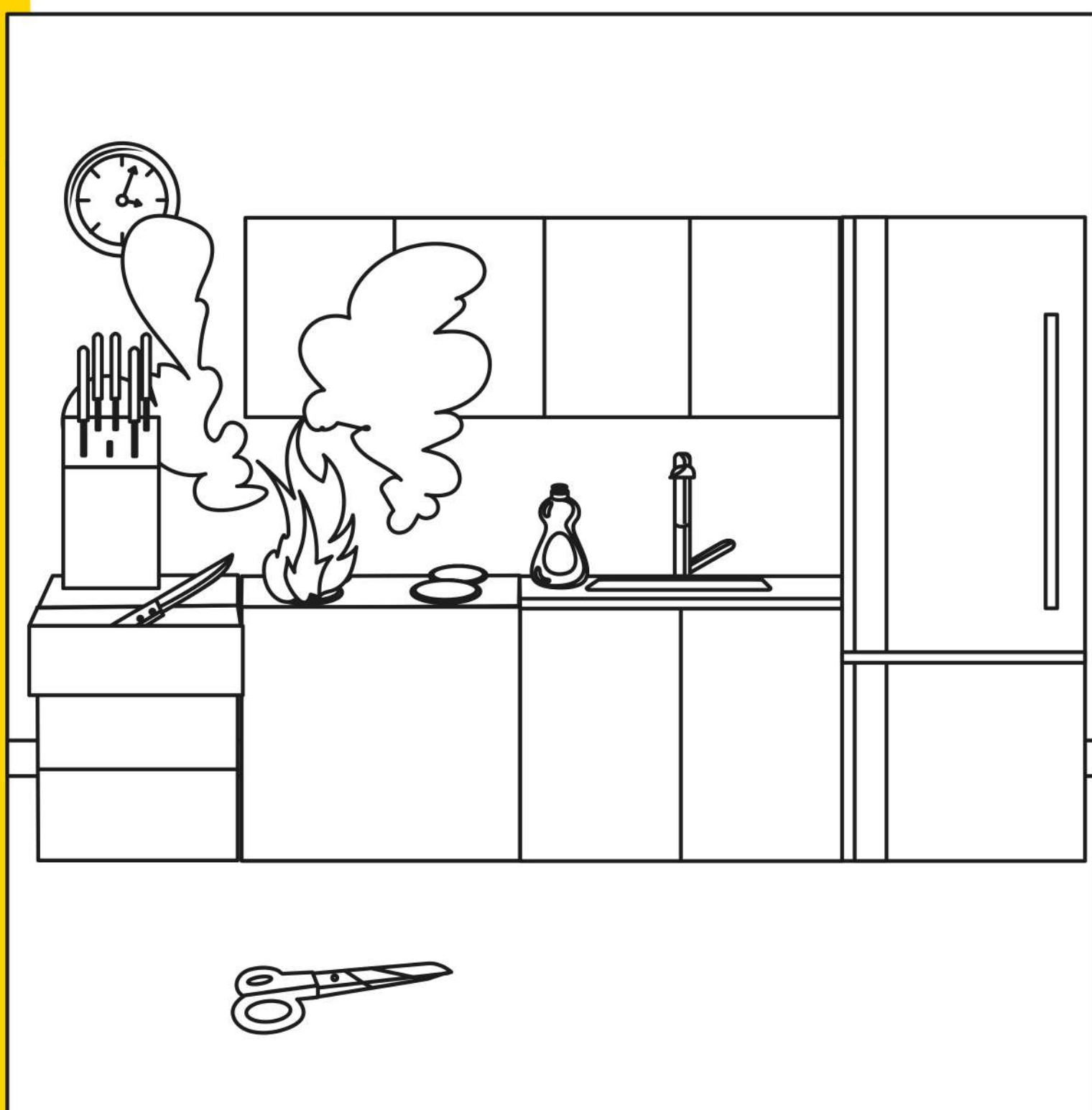
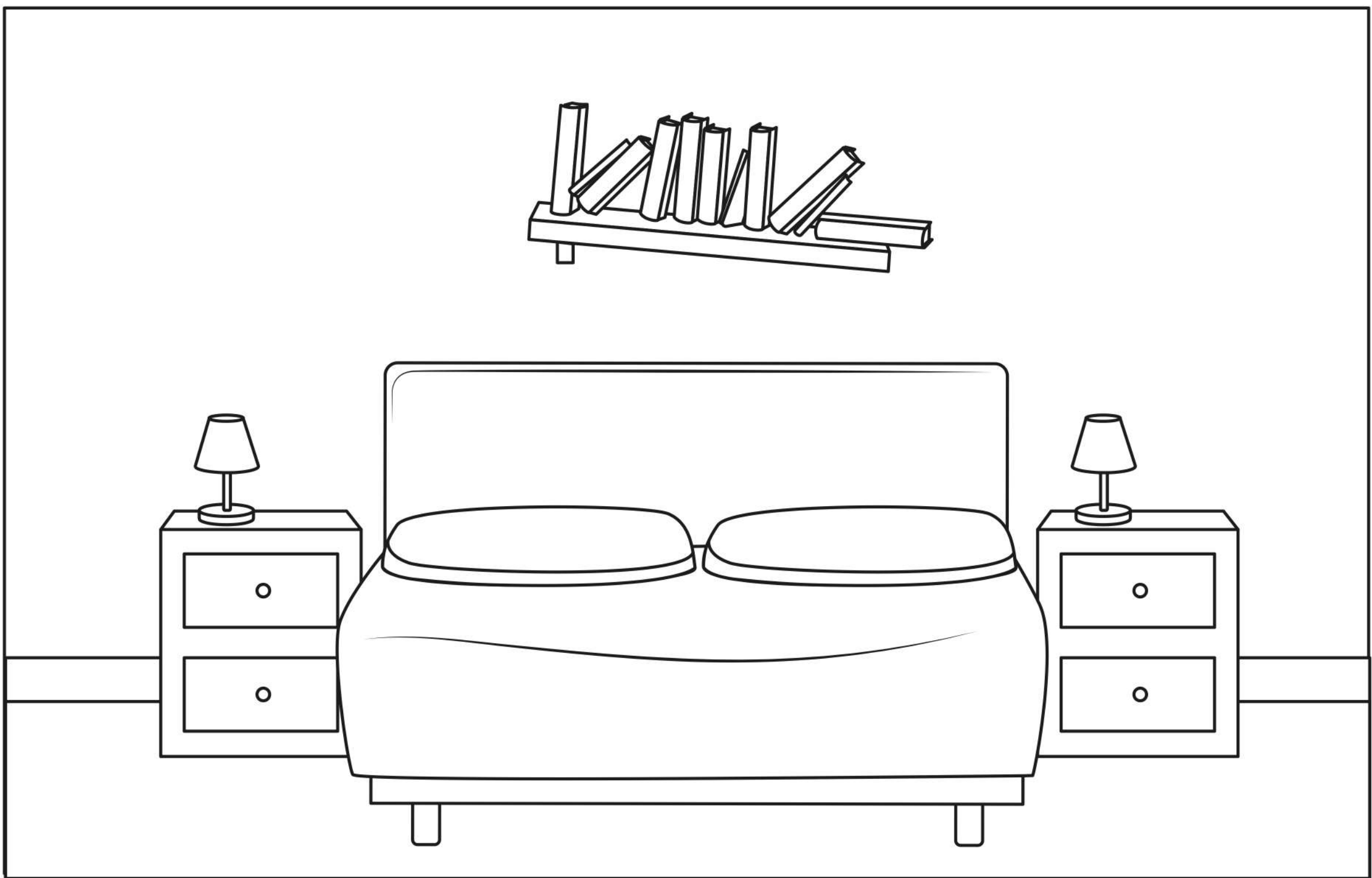

4 - 8 YEARS



First Aid  
Reference  
Centre

# FIRST-AID KIT

Color the objects  
that fit in the first aid  
kit.

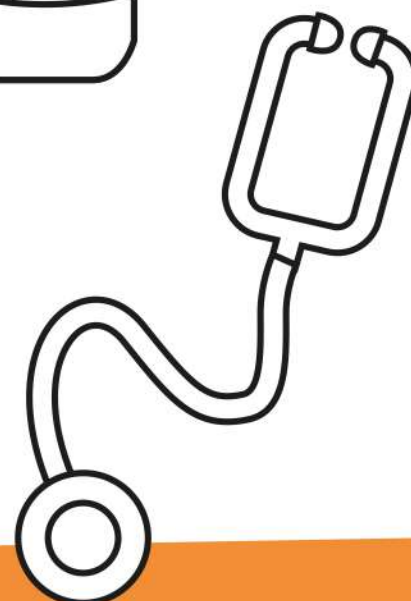
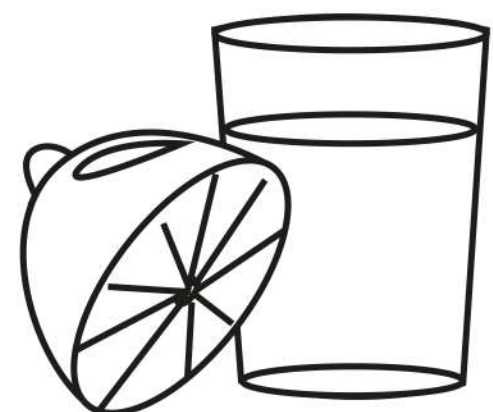
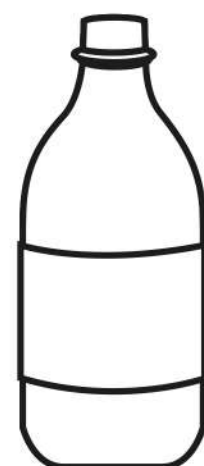
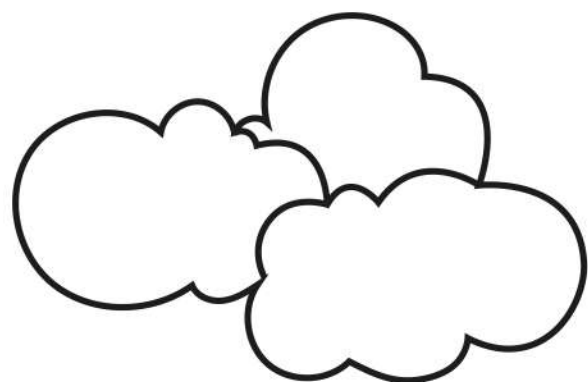
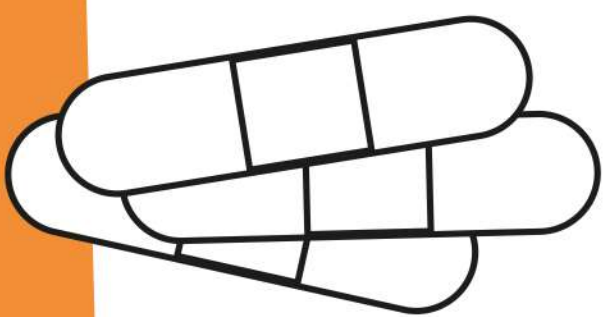
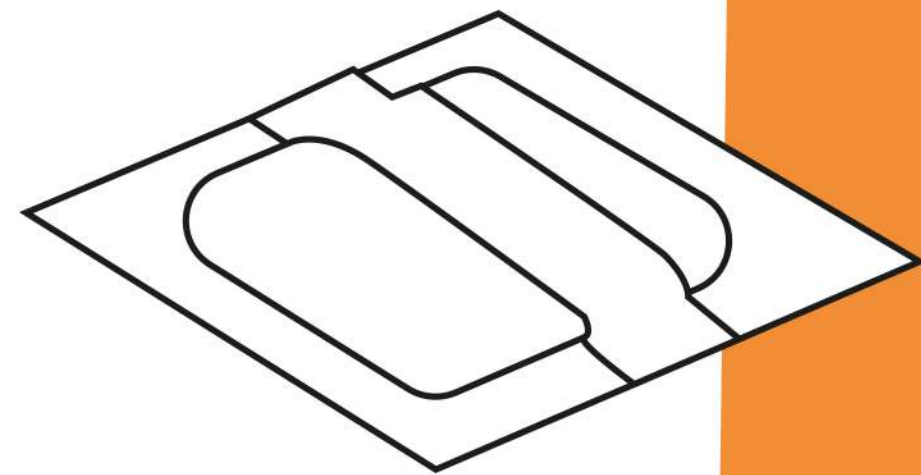
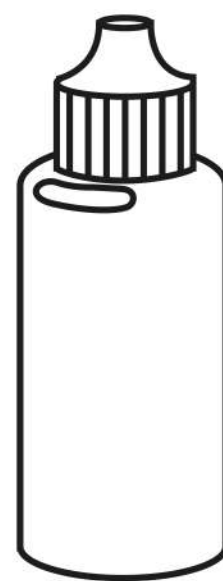
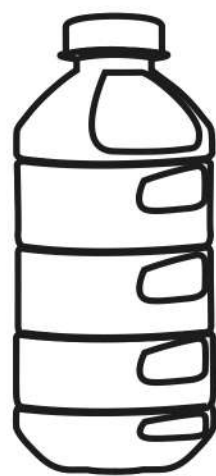
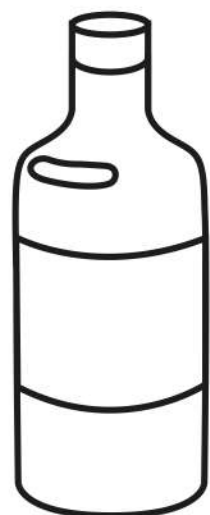
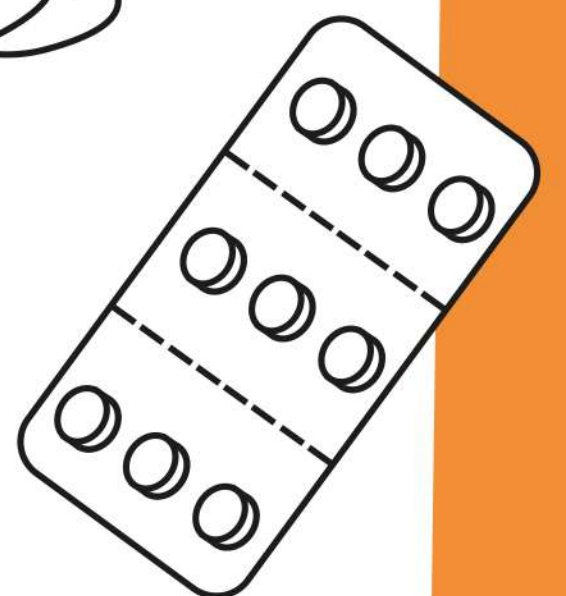
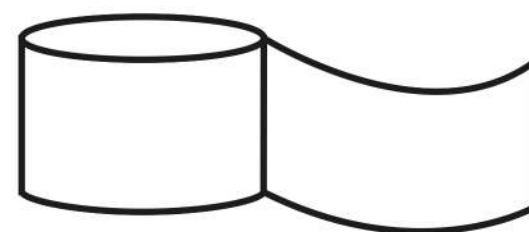
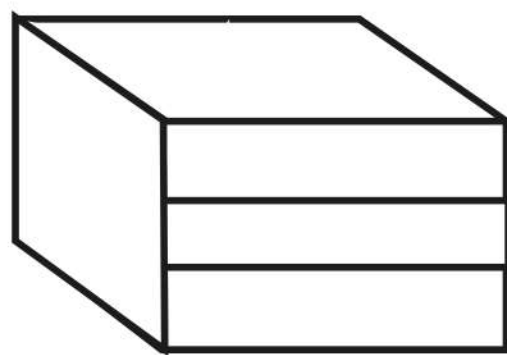
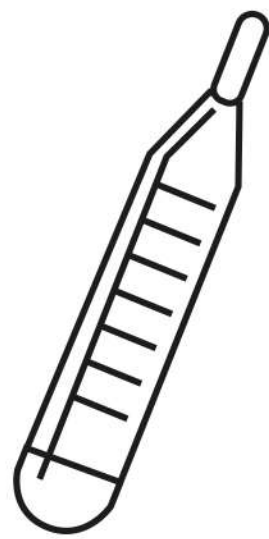
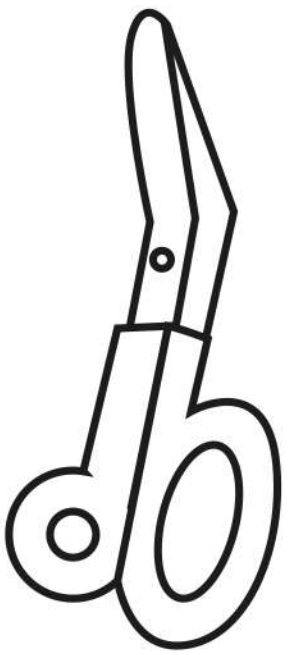
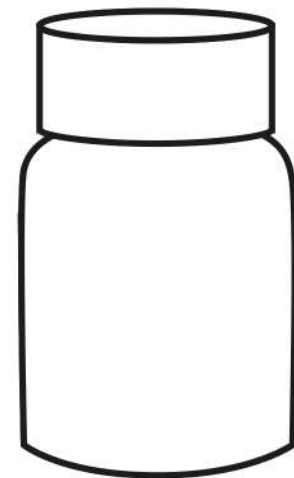
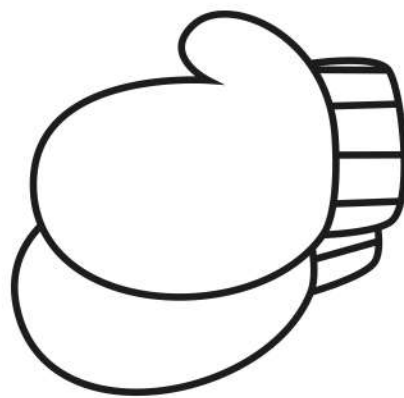
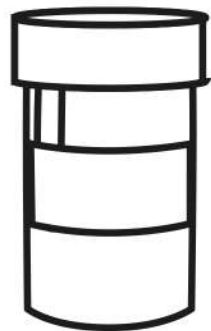
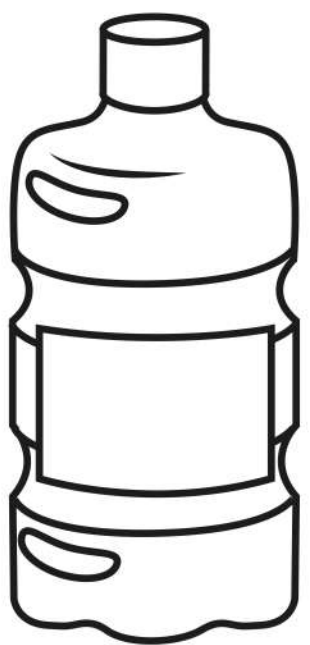
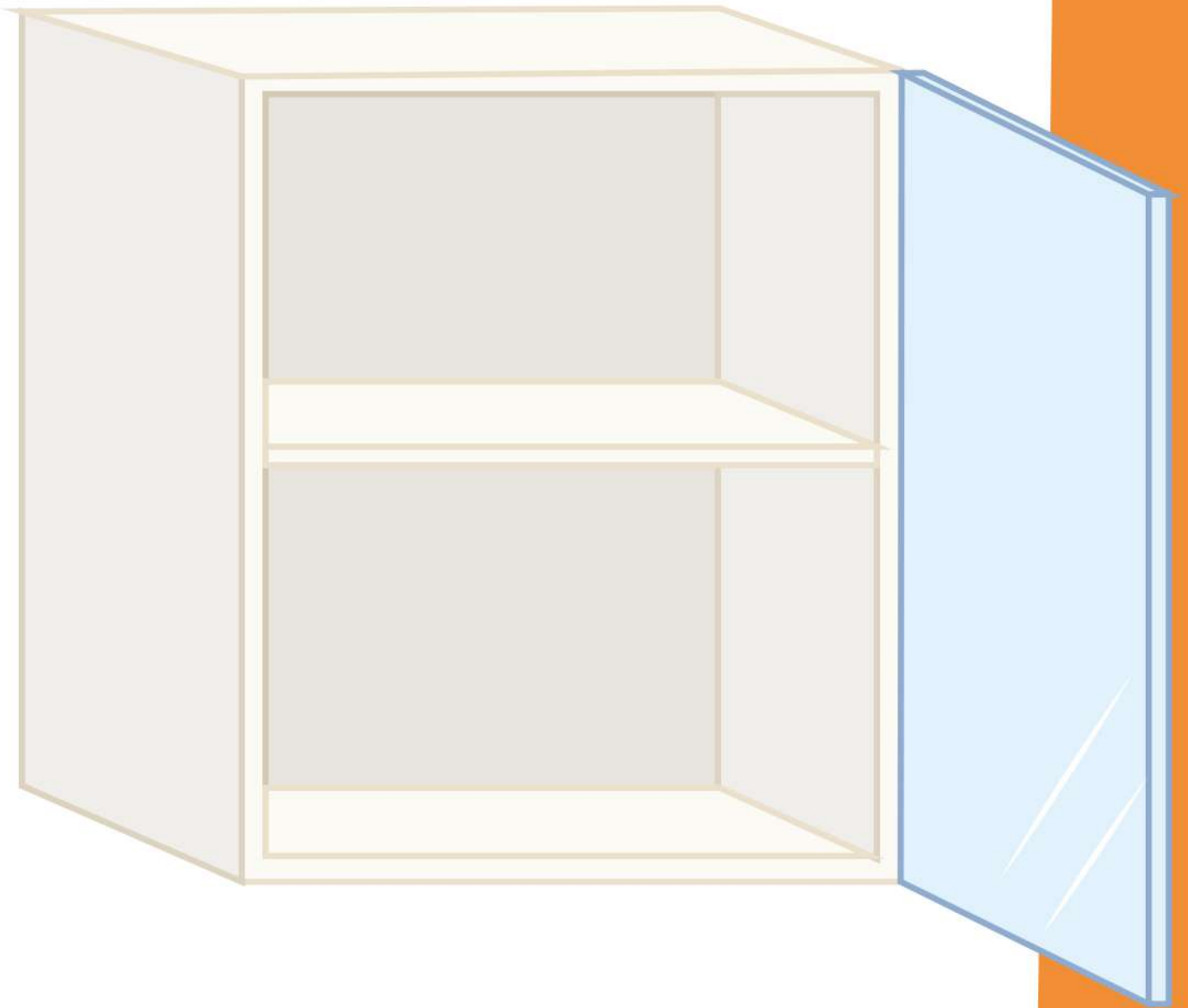

4 - 8 YEARS



First Aid  
Reference  
Centre

# RECOGNIZE & RESPOND

## TO AN EMERGENCY

Write in the grey box the telephone number that  
corresponds to **each vehicle.** Then, color.

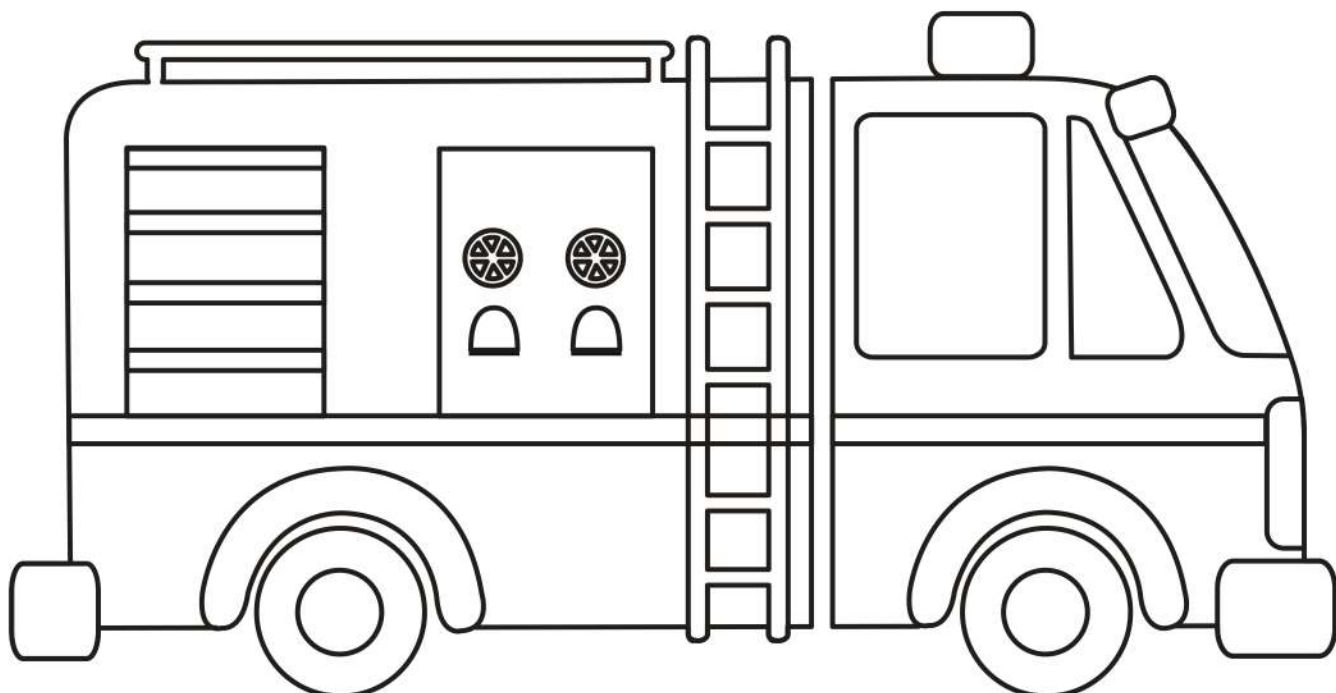
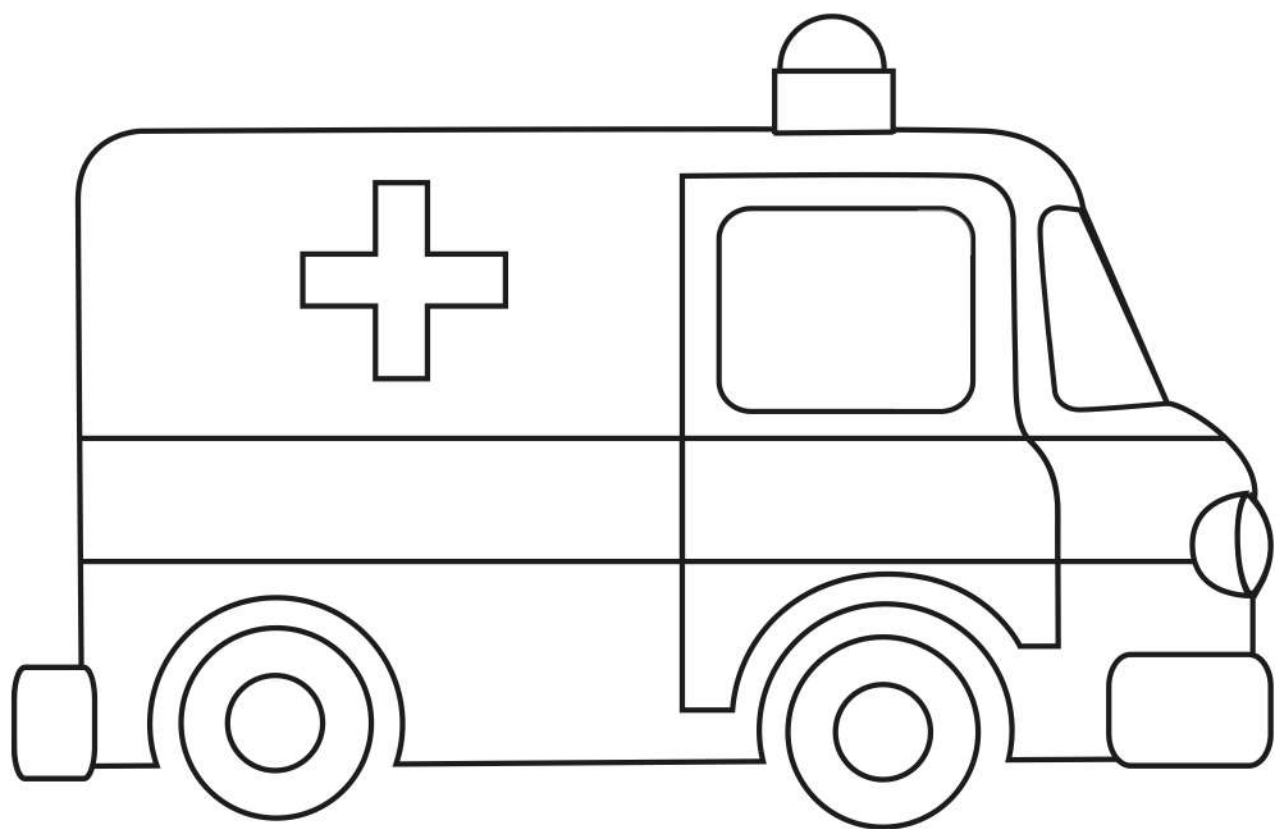
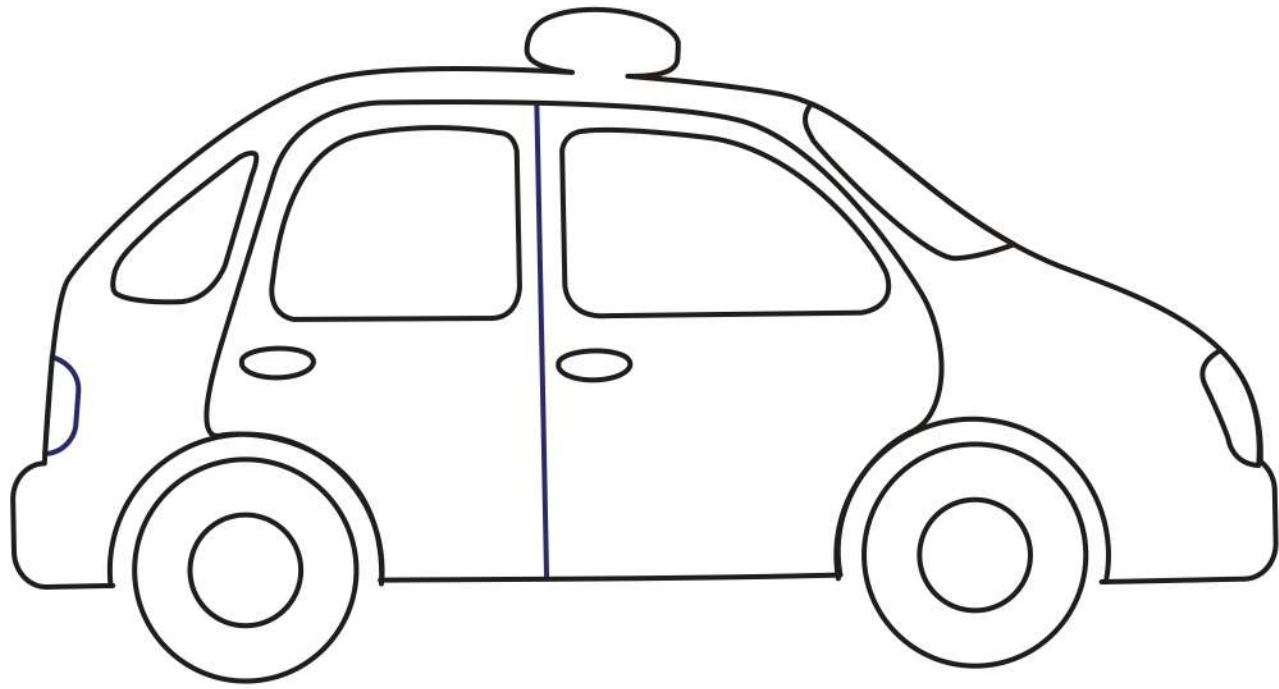

4 - 8 YEARS



First Aid  
Reference  
Centre

# WOUNDS & BLEEDING

## CUTS AND GRAZES

### DAILY BURNS

Using arrows connect each situation. Then color.

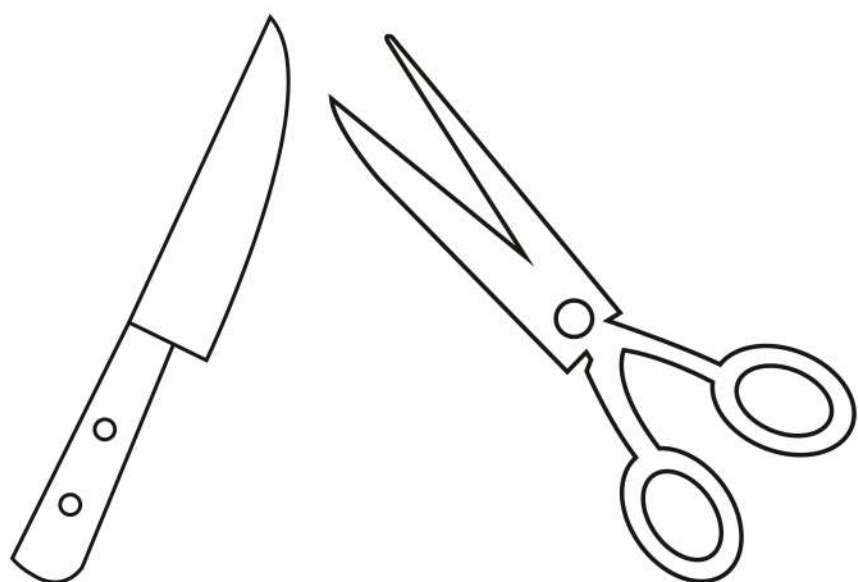
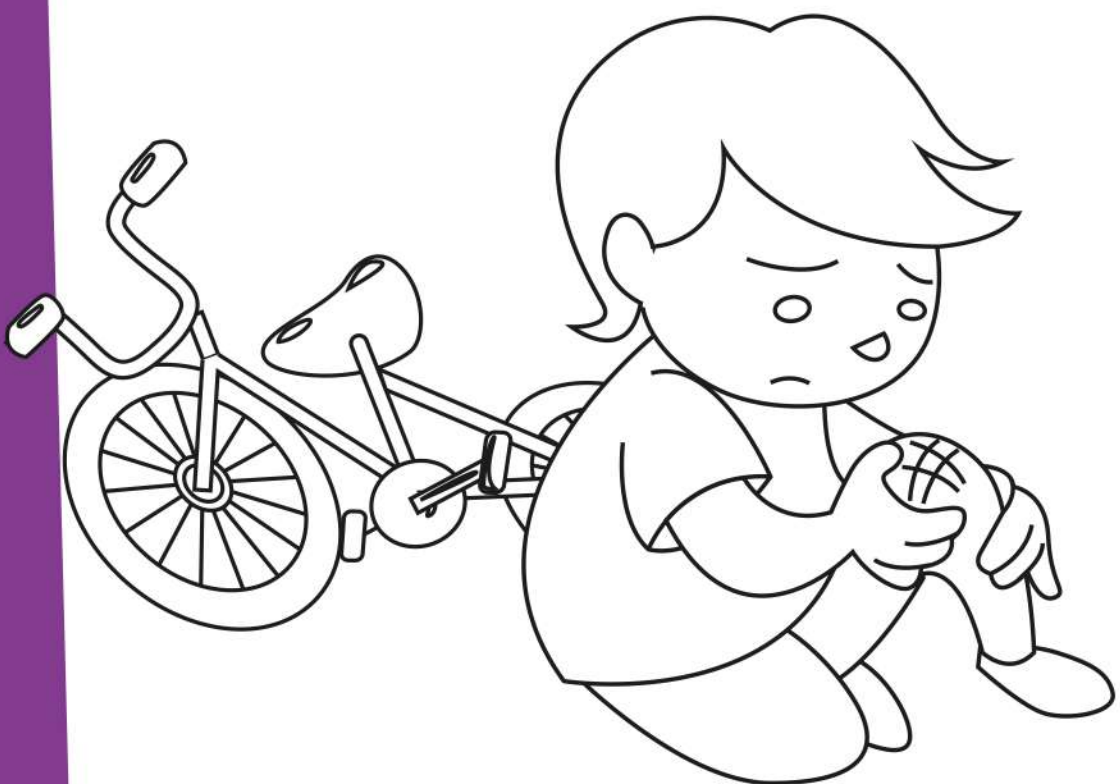
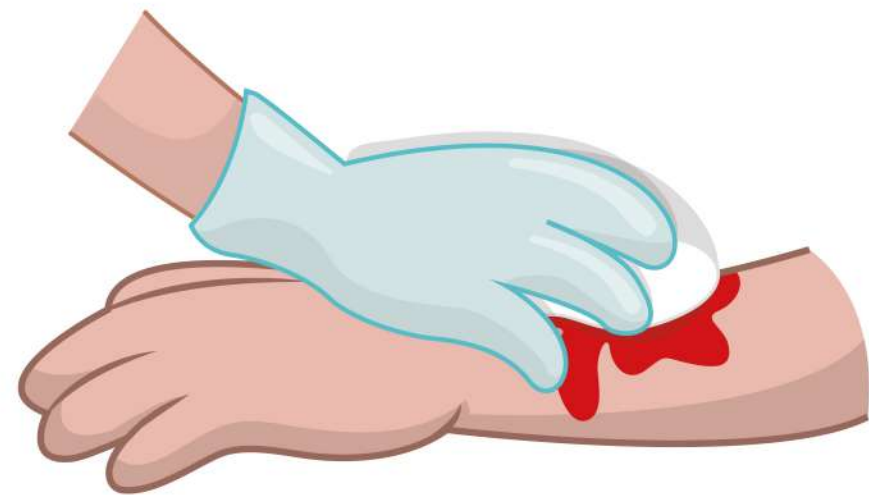

4 - 8 YEARS

# CARDIOPULMONARY RESCUSCITATION (CPR)

## STROKE

### CHOKING : OBSTRUCTED AIRWAY MANEUVER

Color the same as **the image in color.**

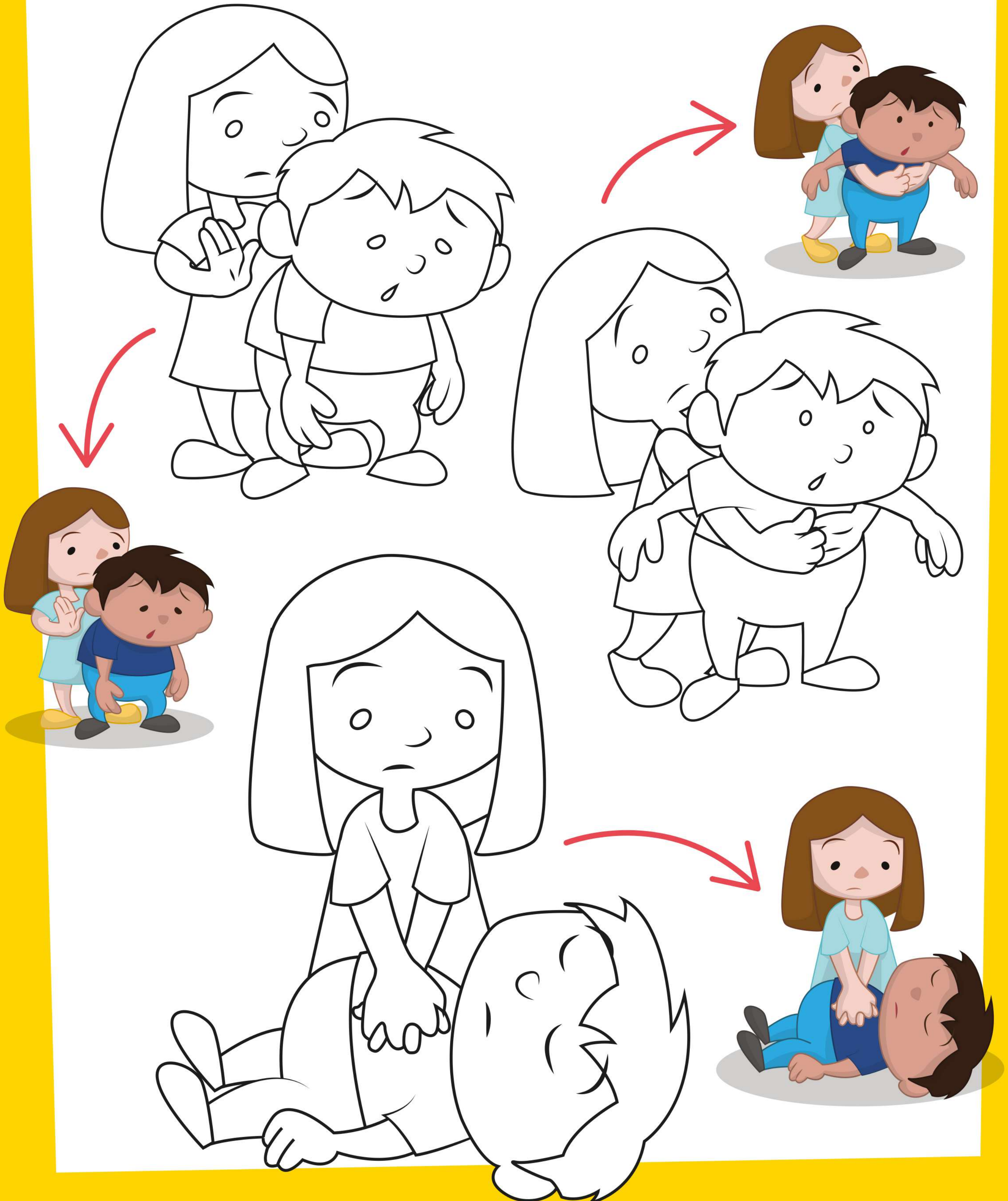

4 - 8 YEARS



First Aid  
Reference  
Centre

# INTOXICATION

Cross out **toxic** products.

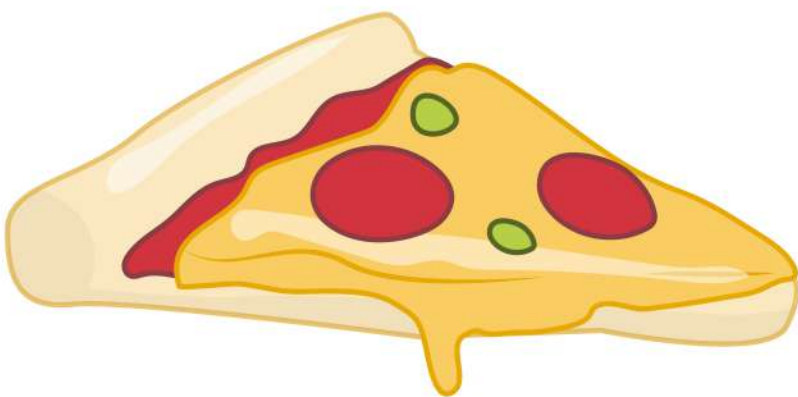
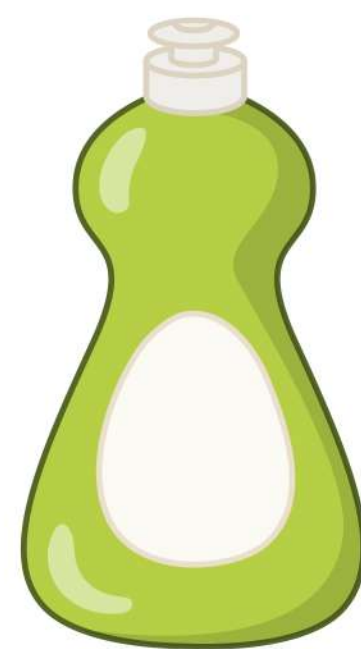
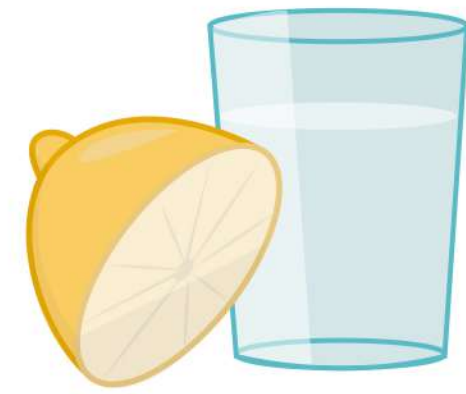
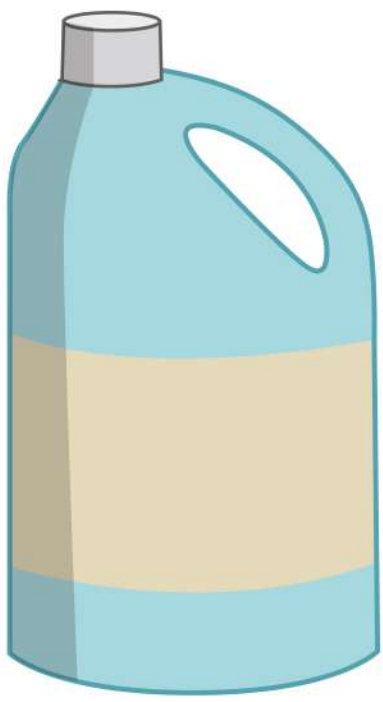

4 - 8 YEARS

# RISKS RELATED TO COLD OR HEAT

How to protect yourself from cold or heat? Connect the images using arrows.





4 - 8 YEARS

# INSECT STINGS

# ANIMAL BITES

Connect with arrows the type of bite/sting that corresponds to each animal/insect.

